

VDMA Compact Cylinders
VDMA 24562
Magnetic Piston
Single Acting
 \varnothing 20 to 63 mm

- The mountings of VDMA 24562 can be used
- M/50 – Switches can be mounted flush with the profile
- Magnetic piston as standard
- VDMA pitch as standard (\varnothing 32 to 63 mm)
- Seals ensure low friction operation and long life



Technical Data

Medium:

Compressed air, filtered, lubricated or non-lubricated

Standard:

VDMA 24562 (Pitch and mountings) \varnothing 32 to 63 mm
 UNITOP (Pitch) \varnothing 20 and 25 mm

Operation:

RM/191000/M	Single acting, sprung in, magnetic piston, male piston rod thread, buffer cushioning
RM/191000/MX	Single acting, sprung in, magnetic piston, female piston rod thread, buffer cushioning
RM/193000/M	Single acting, sprung out, magnetic piston, male piston rod thread, buffer cushioning
RM/193000/MX	Single acting, sprung out, magnetic piston, female piston rod thread, buffer cushioning

Operating Pressure:

2 to 10 bar

Operating Temperature:

-5°C* to +80°C max.

* Consult our Technical Service for use below +2°C

Cylinder Diameters:

20, 25, 32, 40, 50, 63 mm

Strokes:

Standard: 5, 10, 25 mm

Non-standard strokes available (50 mm max.)

Materials:

Profile barrel: Anodised aluminium

End covers: Anodised aluminium

Piston rod: Stainless steel (\varnothing 20 and 25 mm Austenitic, \varnothing 32 to 63 mm Martensitic)

Piston rod seals: Polyurethane

Piston seals: Nitrile rubber

'O'-rings: Nitrile rubber

Ordering Examples

See page N 1.4.087.03

Mountings and Switches

See page N 1.4.087.02 and .03

Alternative Models

Double acting cylinders

See page
N 1.5.095

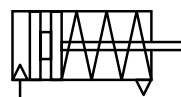

Sprung in

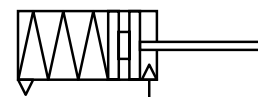

Sprung out

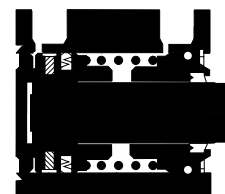



Cylinder Variants

Symbol	Model	Description	Dimensions Page
	RM/191000/M	Standard cylinder, male piston rod thread	4
	RM/191000/MX	Standard cylinder, female piston rod thread	4
	RM/191000/MU	Cylinder with extended piston rod, male piston rod thread	4
	RM/191000/MUX	Cylinder with extended piston rod, female piston rod thread	5
	RM/191000/N2	Cylinder with non-rotating piston rod, male piston rod thread	5
	RM/191000/N2X	Cylinder with non-rotating piston rod, female piston rod thread	5
	RM/193000/M	Standard cylinder, male piston rod thread	4
	RM/193000/MX	Standard cylinder, female piston rod thread	4
	RM/193000/MU	Cylinder with extended piston rod, male piston rod thread	4
	RM/193000/MUX	Cylinder with extended piston rod, female piston rod thread	4
	RM/193000/N2	Cylinder with non-rotating piston rod, male piston rod thread	5
	RM/193000/N2X	Cylinder with non-rotating piston rod, female piston rod thread	5

For combinations of cylinder variants consult our Technical Service.

Model Codes

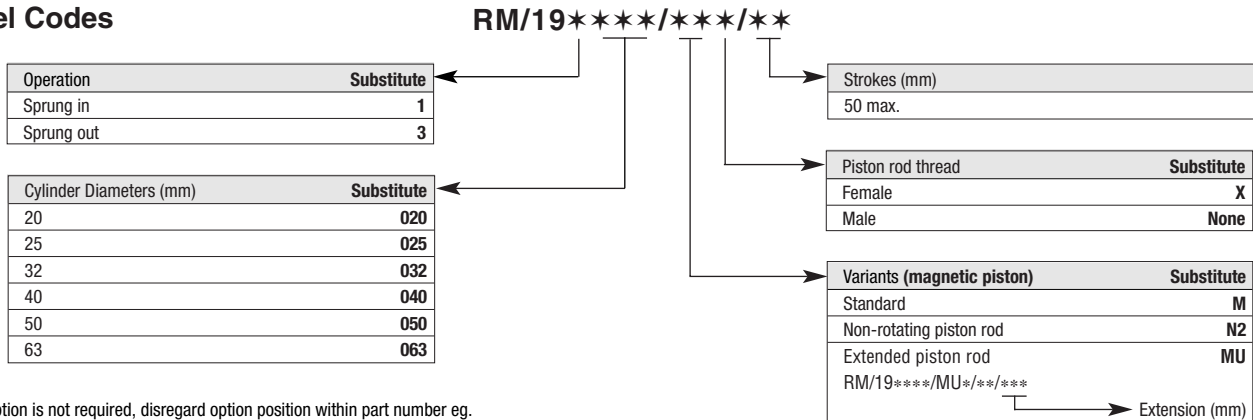

Note: If option is not required, disregard option position within part number eg. RM/191032/M/25. For combinations of cylinder variants consult our Technical Service.

Switches

Model	Cable	Plug (M8x1)
Reed	M/50/LSU/.. M/50/RAC/5V	M/50/LSU/CP —
Solid state	M/50/EAP/.. M/50/EAN/..	M/50/EAP/CP M/50/EAN/CP

Reed	Model	Voltage V a.c.	V d.c.	Current Max.	Temperature °C	LED	Features	Cable/Plug	Cable Type	Plug-in Cable Straight	90°	Catalogue Page
—	M/50/LSU*/V	10 to 240	10 to 170	180 mA	-20° to +80°	●	—	2, 5, 10 m	PVC 2 x 0,25	—	—	N 4.3.005
—	M/50/LSU/5U	10 to 240	10 to 170	180 mA	-20° to +80°	●	—	5 m	PUR 2 x 0,25	—	—	N 4.3.005
—	M/50/RAC/5V	10 to 240	10 to 170	180 mA	-20° to +80°	—	Changeover	5 m	PVC 3 x 0,25	—	—	N 4.3.005
—	M/50/LSU/CP	10 to 60	10 to 75	180 mA	-20° to +80°	●	—	Plug M8x1	—	M/P73001/5	—	N 4.3.005
—	M/50/EAP*/V	—	10 to 30	150 mA	-20° to +80°	●	PNP	2, 5, 10 m	PVC 3 x 0,25	—	—	N 4.3.007
—	M/50/EAP/CP	—	10 to 30	150 mA	-20° to +80°	●	PNP	Plug M8x1	—	M/P73001/5	—	N 4.3.007
—	M/50/EAN*/V	—	10 to 30	150 mA	-20° to +80°	●	NPN	2, 5, 10 m	PVC 3 x 0,25	—	—	N 4.3.007
—	M/50/EAN/CP	—	10 to 30	150 mA	-20° to +80°	●	NPN	Plug M8x1	—	M/P73001/5	—	N 4.3.007

* Insert cable length

Full information on switches (technical data, cable materials, dimensions etc.) please refer to relevant catalogue pages











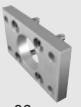



Standard Strokes

Cylinder ∅	Strokes (mm)		
	5	10	25
20	●	●	
25	●	●	
32		●	●
40		●	●
50		●	●
63		●	●

Non standard strokes available (50 mm)

Mountings

Cylinder ∅	Style 'A'	Style 'B', 'G'	Style 'C'	Style 'D'	Style 'D2'	Style 'FH'	Style 'L2'	Style 'R'
		 Page 06	 Page 06	 Page 06	 Page 07	 Page 08	 Page 10	 Page 09
20	–	QM/192020/22	QM/192020/21	–	–	–	QM/8020/44	QM/192020/27
25	–	QM/192025/22	QM/192025/21	–	–	–	QM/8020/44	QM/192025/27
32	QM/8032/35	QA/8032/22	QA/8032/21	QA/8032/23	QA/8032/42	QA/8032/34	–	QA/8032/27
40	QM/8032/35	QA/8040/22	QA/8040/21	QA/8040/23	QA/8040/42	QA/8040/34	–	QA/8040/27
50	QM/8050/35	QA/8050/22	QA/8050/21	QA/8050/23	QA/8050/42	QA/8050/34	–	QA/8050/27
63	QM/8050/35	QA/8063/22	QA/8063/21	QA/8063/23	QA/8063/42	QA/8063/34	–	QA/8063/27
Cylinder ∅	Style 'S'	Style 'SS'	Style 'SW'	Style 'UH'	Style 'UR'	Style 'US'	Groove Key	
	 Page 10	 Page 11	 Page 07	 Page 10	 Page 09	 Page 08	 Page 13	
20	–	–	–	–	–	–	M/P72816	
25	–	–	–	–	–	–	M/P72816	
32	QA/8032/41	M/P19931	M/P19493	PQA/182032/40	QA/8032/33	M/P40310	M/P72816	
40	QA/8040/41	M/P19932	M/P19494	PQA/182040/40	QA/8040/33	M/P40311	M/P72816	
50	QA/8040/41	M/P19933	M/P19495	PQA/182050/40	QA/8050/33	M/P40312	M/P72816	
63	QA/8063/41	M/P19934	M/P19496	PQA/182063/40	QA/8063/33	M/P40313	M/P72816	

For cylinders with male piston rod thread

Cylinder ∅	Style 'AK'	Style 'F'	Style 'N2'	Style 'UF'	Style 'F'	Style 'N2'	Stud or Adaptor
		 Page 13	 Page 11	 Page 13	 Page 13	 Page 12	 Page 12
20	QM/8025/38	QM/8025/25	M/P1501/89	QM/8025/32	QM/57016/25	M/P1501/79	M/P1710/21#
25	QM/8025/38	QM/8025/25	M/P1501/89	QM/8025/32	QM/57016/25	M/P1501/79	M/P1710/21#
32	QM/8025/38	QM/8025/25	M/P1501/89	QM/8025/32	QM/57020/25	M/P1501/60	M/P1710/22#
40	QM/8040/38	QM/8040/25	M/P1501/90	QM/8040/32	QM/57020/25	M/P1501/60	M/P1710/22#
50	QM/8050/38	QM/8050/25	M/P1501/91	QM/8050/32	QM/57025/25	–	M/P71470/1##
63	QM/8050/38	QM/8050/25	M/P1501/91	QM/8050/32	QM/57040/25	–	M/P71470/2##

Stud, ## Adaptor

Ordering Examples

Cylinders

To order a standard 50 mm bore magnetic piston cylinder with a 25 mm stroke and male piston rod thread quote: **RM/191050/M/25**

Mountings

To order a front flange mounting style 'G' for 50 mm bore cylinder quote: **QA/8050/22**

Switches

To order a reed switch with LED and 2 m cable length quote: **M/50/LSU/2V**



Theoretical Forces • Air Consumption

Cylinder Ø	RM/191000/M Theoretical forces (N) at 6 bar Outstroke		RM/193000/M Theoretical forces (N) at 6 bar Instroke		Air consumption (l/cm stroke) at 6 bar Outstroke		Instroke
	F1	F1	F1	F1			
20	161	14,5	119	14,5	0,022	0,017	
25	264	20	197	20	0,035	0,027	
32	432	32	311	32	0,056	0,042	
40	687	44	566	44	0,088	0,074	
50	1043	56,5	906	56,5	0,138	0,116	
63	1770	74,5	1582	74,5	0,218	0,196	

Basic Dimensions

RM/191000/MX – Standard Cylinders

Sprung in with female piston rod thread

RM/191000/M – Standard Cylinders

Sprung in with male piston rod thread

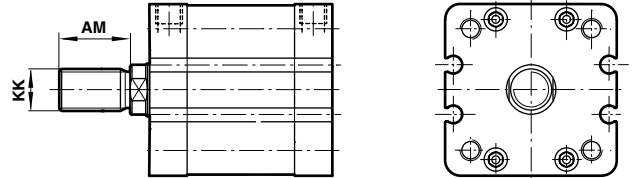
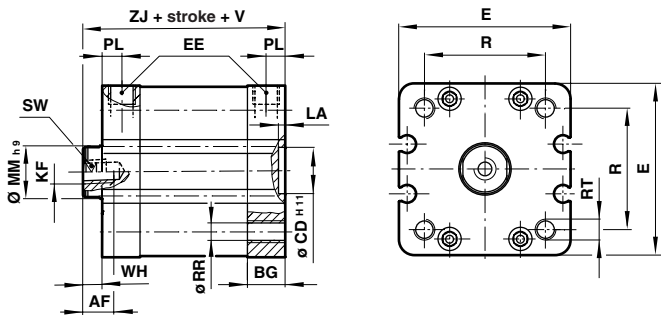

RM/193000/MX – Standard Cylinders

Sprung out with female piston rod thread

RM/193000/M – Standard Cylinders

Sprung out with male piston rod thread

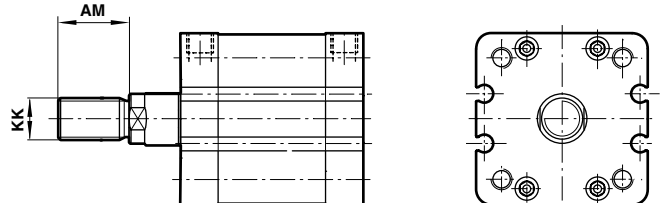
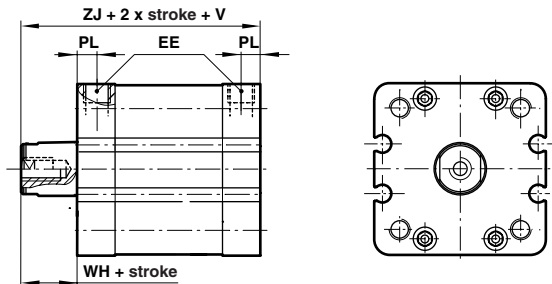

Cylinder Ø	AF	AM	BG	Ø CD H11	E		EE	KF	KK	LA	Ø MM H9	PL	R
					□	□							
20	10	22	12	12	36	M 5	M 5	M 6	M10x1,25	2,5	10	7,5	22
25	10	22	13	12	40	M 5	M 5	M 6	M10x1,25	2,5	10	7,5	26
32	12	22	14,5	14	47	G 1/8	M 8	M 8	M10x1,25	2,5	12	7,5	32,5
40	12	24	14,5	14	53	G 1/8	M 8	M 8	M12x1,25	2,5	16	7,5	38
50	14	32	14,5	18	65,5	G 1/8	M 10	M 10	M16x1,5	2,5	20	7,5	46,5
63	16	32	14,5	18	75	G 1/8	M 12	M 12	M16x1,5	2,5	20	7,5	56,5

Cylinder Ø	Ø RR	RT	SW (A/F)	V		WH	ZJ	RM/191000/MX		RM/193000/MX	
				0 to 25	26 to 50			at 0 mm	per 5 mm	at 0 mm	per 5 mm
20	4,3	M 5	8	17	34	6	43	0,17 kg	0,01 kg	0,17 kg	0,01 kg
25	4,3	M 5	8	18	36	6	45	0,20 kg	0,01 kg	0,20 kg	0,01 kg
32	5,3	M 6	10	19	38	7	51	0,30 kg	0,02 kg	0,30 kg	0,02 kg
40	5,3	M 6	13	20	40	7	52	0,40 kg	0,02 kg	0,40 kg	0,02 kg
50	6,8	M 8	17	30	60	8	53	0,65 kg	0,03 kg	0,65 kg	0,03 kg
63	6,8	M 8	17	30	60	8	58	0,90 kg	0,03 kg	0,90 kg	0,03 kg



Cylinder Variants

RM/191000/N2X – Cylinder with Non-rotating Piston Rod
Sprung in with female piston rod thread

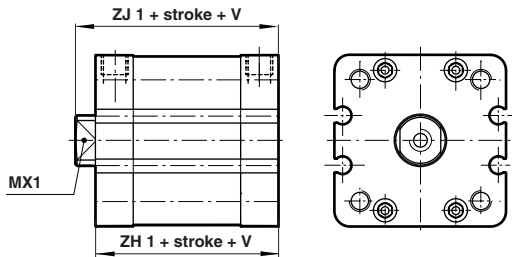

RM/191000/N2 – Cylinder with Non-rotating Piston Rod
Sprung in with male piston rod thread

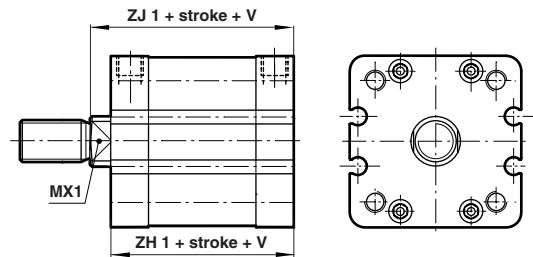

RM/193000/N2X – Cylinder with Non-rotating Piston Rod
Sprung out with female piston rod thread

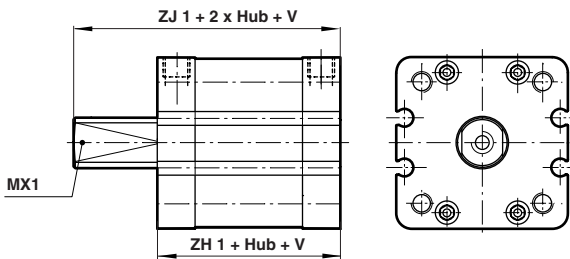

RM/193000/N2 – Cylinder with Non-rotating Piston Rod
Sprung out with male piston rod thread

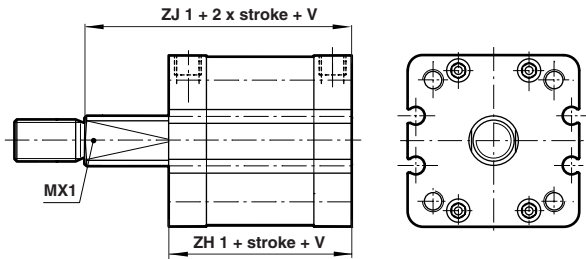

Cylinder \varnothing	MX1	V		ZH1	ZJ1
		0 to 25 mm	26 to 50 mm		
20	8	17	34	47	53
25	8	18	36	49	55
32	10	19	38	54	61
40	13	20	40	55	62
50	16	30	60	55	63
63	16	30	60	60	68

Torque for Cylinders RM/190000/N2

Cylinder \varnothing	Model	Torque max. (Nm)
20	RM/190020/N2	0,15
25	RM/190025/N2	0,25
32	RM/190032/N2	0,40
40	RM/190040/N2	0,75
50	RM/190050/N2	1,5
63	RM/190063/N2	1,5



Mountings

QM/8000/35 – Rear or Rear Stud Mounting Style ‘A’ (Corresponds to DIN ISO 6431 Style MX1)

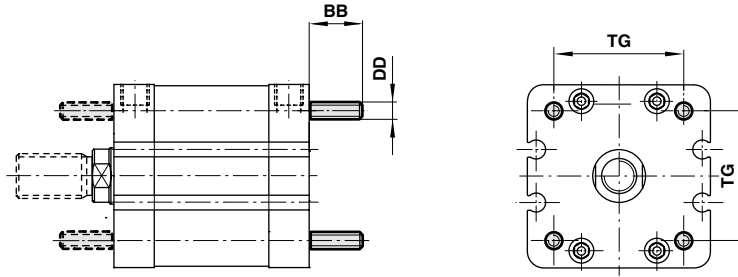

QA/8000/22 – Rear Flange Mounting Style ‘B’ (Corresponds to DIN ISO 6431 and VDMA 24562 Part 2, Style MF2)

QA/8000/22 – Front Flange Mounting Style ‘G’ (Corresponds to DIN ISO 6431 and VDMA 24562 Part 2, Style MF1)

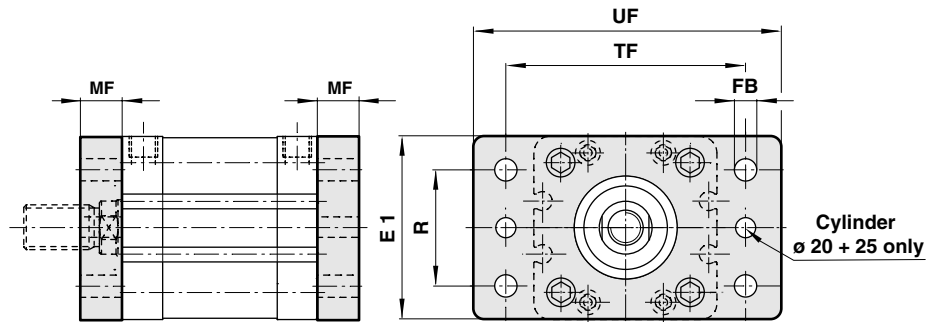

QA/8000/21 – Foot Mounting Style ‘C’ (Corresponds to DIN ISO 6431 and VDMA 24562 Part 2, Style MS1)

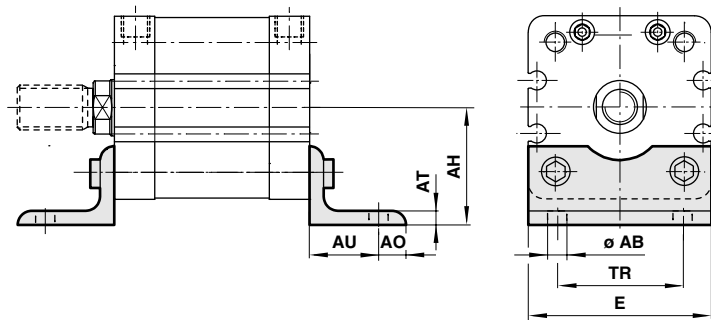

Cylinder \varnothing	\varnothing AB	AH	A0	AT	AU	BB	DD	E	E1	\varnothing FB
20	6,6	27	6	4	16	–	–	36	36	6,6
25	6,6	30	7	4	16	–	–	40	40	6,6
32	7	32	8	4	24	17	M6	48	50	7
40	9	36	9	4	28	17	M6	53	55	9
50	9	45	10	5	32	23	M8	64	65	9
63	9	50	12	5	32	23	M8	74	75	9

Cylinder \varnothing	MF	R	TF	TG	TR	UF	Style ‘A’	Style ‘B’, ‘G’	Style ‘C’
20	10	–	55	–	22	70	–	0,16 kg	0,03 kg
25	10	–	60	–	26	76	–	0,20 kg	0,04 kg
32	10	32	64	32,5	32	80	0,02 kg	0,25 kg	0,15 kg
40	10	36	72	38	36	90	0,02 kg	0,35 kg	0,18 kg
50	12	45	90	46,5	45	110	0,05 kg	0,70 kg	0,30 kg
63	12	50	100	56,5	50	125	0,05 kg	0,80 kg	0,39 kg



QA/8000/23 – Rear Clevis Mounting Style ‘D’
 (Corresponds to DIN ISO 6431 and VDMA 24562 Part 2, Style MP2)

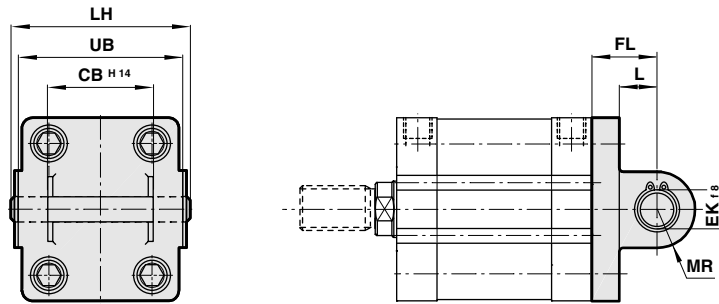

M/P194 . . – Bracket Style ‘SW’
 (Corresponds to VDMA 24562, Part 2)
 For Clevis Mounting Style ‘D’

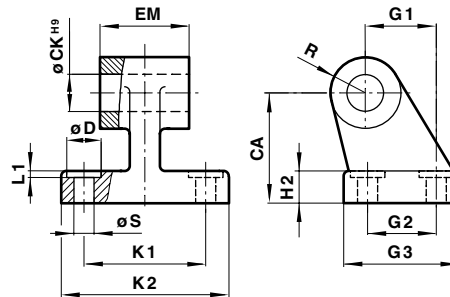

Cylinder Ø	CA	CB H14	Ø CK H9	Ø D	Ø EK I8	EM	FL	G 1	G 2	G 3	H 2
32	32	26	10	11	10	26	22	21	18	31	8
40	36	28	12	11	12	28	25	24	22	35	10
50	45	32	12	15	12	32	27	33	30	45	12
63	50	40	16	15	16	40	32	37	35	50	12
Cylinder Ø	K 1	K 2	L	L 1	LH	MR	R	Ø S	UB	Style 'D'	Style 'SW'
32	38	51	13	1,6	52	9	10	6,6	45	0,11 kg	0,05 kg
40	41	54	16	1,6	60	12	11	6,6	52	0,16 kg	0,07 kg
50	50	65	17	1,6	68	12	13	9	60	0,22 kg	0,14 kg
63	52	67	22	1,6	79	15	15	9	70	0,34 kg	0,18 kg



QA/8000/42 – Rear Clevis Mounting Style ‘D2’
(Corresponds to VDMA 24562 Part 2)

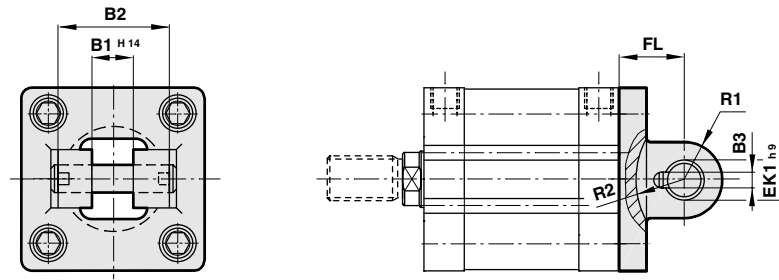

M/P403 . . – Bracket Hinge Style ‘US’
(Corresponds to VDMA 24562 Part 2)
For Clevis Mounting Style ‘D2’

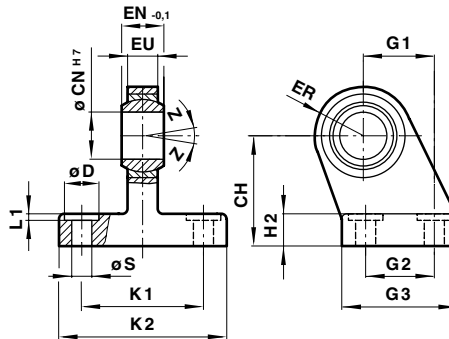

Cylinder \varnothing	B1 H14	B2	B3	CH	\varnothing CN H7	\varnothing D	\varnothing EK h9	EN -0,1	ER	EU	FL	G 1
32	14	34	3,3	32	10	11	10	14	16	10,5	22	21
40	16	40	4,3	36	12	11	12	16	19	12	25	24
50	21	45	4,3	45	16	15	16	21	21	15	27	33
63	21	51	4,3	50	16	15	16	21	24	15	32	37

Cylinder \varnothing	G 2	G 3	H 2	K1	K 2	L1	R1	R2	\varnothing S	Z	Style 'D2'	Style 'US'
32	18	31	8	38	51	1,6	11	17	6,6	13°	0,20 kg	0,19 kg
40	22	35	10	41	54	1,6	12	20	6,6	13°	0,23 kg	0,24 kg
50	30	45	12	50	65	1,6	14,5	22	9	13°	0,36 kg	0,46 kg
63	35	50	12	52	67	1,6	18	25	9	15°	0,55 kg	0,59 kg



QA/8000/27 – Rear Eye Mounting Style ‘R’
(Corresponds to DIN ISO 6431 and VDMA 24562 Part 2, Style MP4)

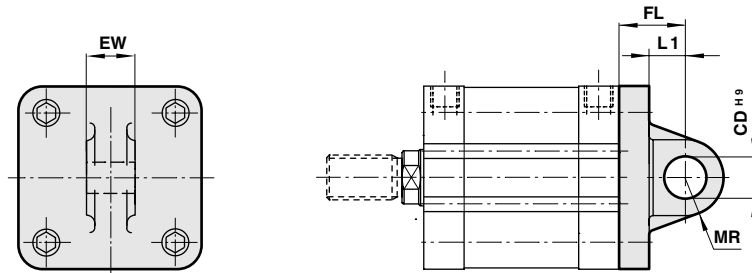

QM/8020/44 – Bracket Hinge Style ‘L2’
For Rear Eye Mounting Style ‘R’

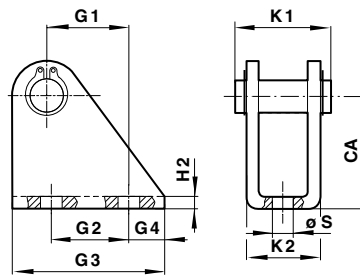

QA/8000/33 – Universal Rear Eye Mounting Style ‘UR’
(Corresponds to VDMA 24562 Part 2)

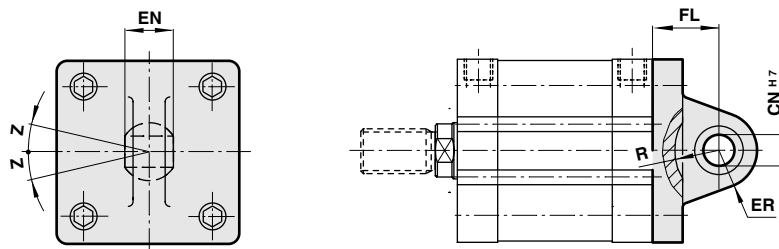

Cylinder \varnothing	CA	\varnothing CD H9	\varnothing CN H7	EN	ER	EW	FL	G 1	G 2	G 3	G 4
20	30	8	–	–	–	15,8	20	16	20	32	6
25	30	8	–	–	–	15,8	20	16	20	32	6
32	–	10	10	14	16	25,8	22	–	–	–	–
40	–	12	12	16	19	27,8	25	–	–	–	–
50	–	12	16	21	21	31,7	27	–	–	–	–
63	–	16	16	21	24	39,7	32	–	–	–	–
Cylinder \varnothing	H2	K 1	K 2	L 1	MR	R	\varnothing S	Z	Style ‘L2’	Style ‘R’	Style ‘UR’
20	4	29,5	24	14	8	–	6,6	–	0,08	0,02	–
25	4	29,5	24	14	8	–	6,6	–	0,08	0,03	–
32	–	–	–	13	9	14,5	–	13°	–	0,09	0,17
40	–	–	–	16	12	18	–	13°	–	0,11	0,25
50	–	–	–	17	12	19	–	13°	–	0,17	0,4
63	–	–	–	22	15	24	–	15°	–	0,24	0,55



QA/8000/34 – Front or Rear Detachable Trunnion Mounting Style ‘FH’

(Corresponds to VDMA 24562 Part 2, Style MT 5/6)

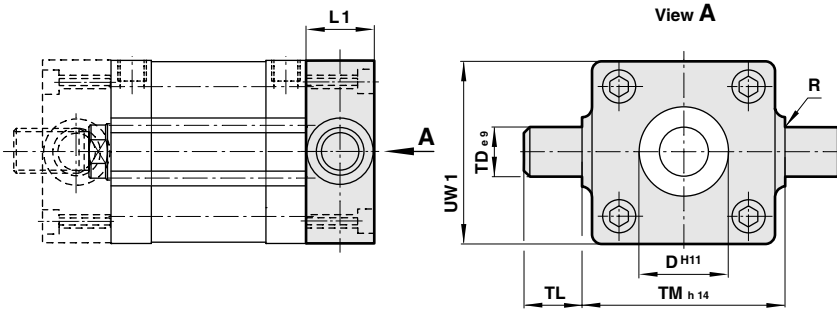

PQA/182000/40 – Adjustable Trunnion Mounting Style ‘UH’

(Corresponds to DIN ISO 6431 and VDMA 24562 Part 2, Style MT4)

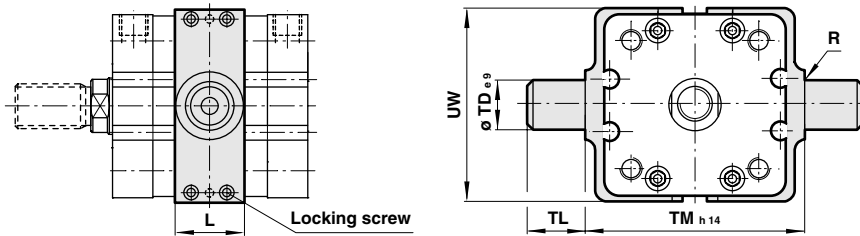

Note:

Style ‘UH’: It is most important that the locking screws which secure the mounting to the cylinder barrel are tightened to the torque figures shown in the table below. For maximum energy input, consult our Technical Service.

QA/8000/41 – Swivel Bearing Style ‘S’

For Trunnion Mountings Style ‘FH’, ‘UH’

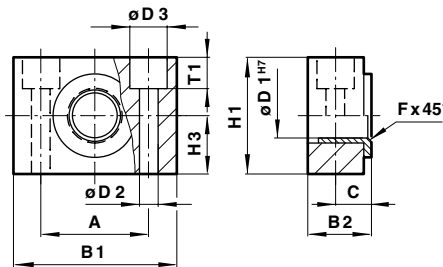

Cylinder \varnothing	A	B 1	B 2	C	$\varnothing D^{H11}$	$\varnothing D 1^{H7}$	$\varnothing D 2$	$\varnothing D 3$	F x 45°	H 1	H 3	L
32	32	46	18	10,5	30	12	6,6	11	1	30	15	25
40	36	55	21	12	35	16	9	15	1,6	36	18	28
50	36	55	21	12	40	16	9	15	1,6	36	18	28
63	42	65	23	13	45	20	11	18	1,6	40	20	36

Cylinder \varnothing	L1	R	$\varnothing TD_{\varnothing 9}$	TL	TM _{h14}	T 1	UW	UW 1	Torque Nm	Style ‘FH’	Style ‘S’	Style ‘UH’
32	16	1	12	12	50	6,8	58	50	2	0,20 kg	0,11 kg	0,16 kg
40	20	1,6	16	16	63	9	65	55	3,5	0,38 kg	0,16 kg	0,35 kg
50	24	1,6	16	16	75	9	80	65	3,5	0,60 kg	0,16 kg	0,65 kg
63	24	1,6	20	20	90	11	76	75	5	1,10 kg	0,23 kg	0,85 kg



QM/8000/25 – Piston Rod Clevis Mounting Style ‘F’

(Corresponds to DIN ISO 8140)

For cylinders with male piston rod thread

Order nut style ‘N2’ separately (page N 1.4.087.03)

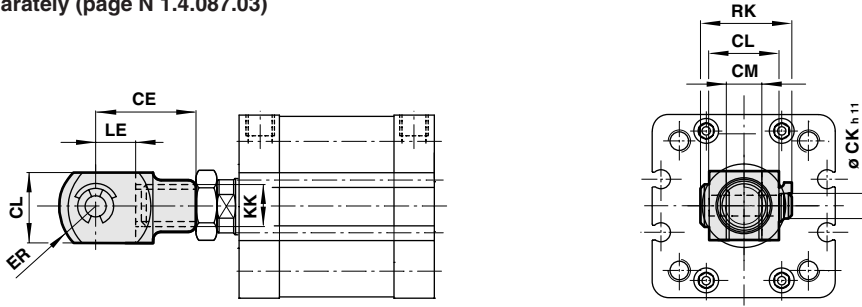

M/P199 . . – Bracket Style ‘SS’

For model QM/8000/25 – Piston Rod Clevis Mounting Style ‘F’

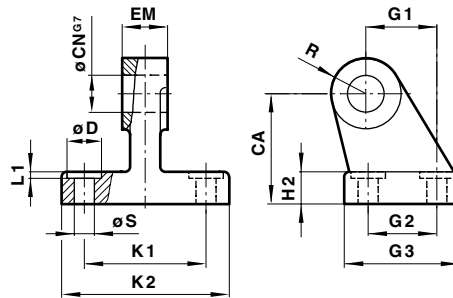

Cylinder Ø	CA	CE	ø CK h11	□ CL	CM	ø CN G7	ø D	EM	ER	G 1	G 2	G 3
20	–	40	10	20	10	–	–	–	16	–	–	–
25	–	40	10	20	10	–	–	–	16	–	–	–
32	32	40	10	20	10	10	11	10	16	21	18	31
40	36	48	12	24	12	12	11	12	19	24	22	35
50	45	64	16	32	16	16	15	16	25	33	30	45
63	50	64	16	32	16	16	15	16	25	37	35	50

Cylinder Ø	H 2	KK	K 1	K 2	L1	LE	R	RK	ø S	Style ‘F’	Style ‘SS’
20	–	M10x1,25	–	–	–	20	–	28	–	0,09 kg	–
25	–	M10x1,25	–	–	–	20	–	28	–	0,09 kg	–
32	8	M10x1,25	38	51	1,6	20	10	28	6,6	0,09 kg	0,15 kg
40	10	M12x1,25	41	54	1,6	24	11	32	6,6	0,13 kg	0,20 kg
50	12	M16x1,5	50	65	1,6	32	13	41,5	9	0,33 kg	0,48 kg
63	12	M16x1,5	52	67	1,6	32	15	41,5	9	0,33 kg	0,50 kg



QM/57000/25 – Piston Rod Clevis Mounting Style 'F'

For cylinders with female piston rod thread

Order stud and nut style 'N2' or adaptor separately (page N 1.4.087.03)

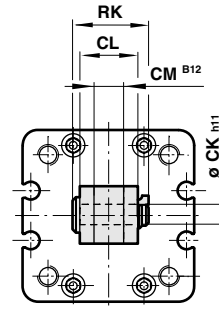
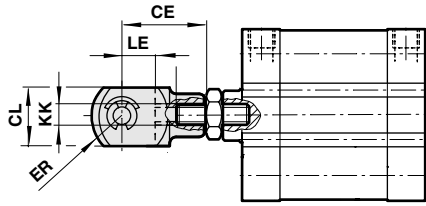

M/1 . . . – Stud and Nut (ø 20 to 40 mm)

M/1470/ . . – Adaptor (ø 50 and 63 mm)

For cylinders with female piston rod thread

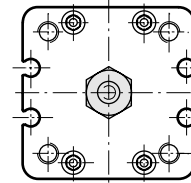
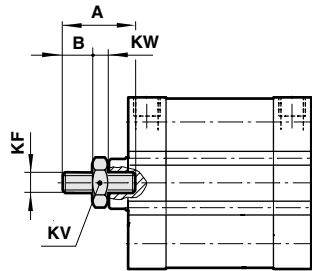

Cylinder Ø	A	B	CE	ø CK h11	□ CL	CM B12	ER	KF
20	25	–	20	5	10	5	8	M5
25	25	–	20	5	10	5	8	M6
32	25	–	24	6	12	6	9,5	M8
40	25	–	24	6	12	6	9,5	M8
50	29	12	26	8	14	7	11,5	M10
63	35	15	40	10	20	10	16	M12

Cylinder Ø	KK	KV	KW	LE	RK	Style 'F'	Nut	Adaptor
20	M6	10	3	10	14,5	0,01 kg	0,01 kg	0,01 kg
25	M6	10	3	10	14,5	0,01 kg	0,01 kg	0,01 kg
32	M8	13	4	12	17,5	0,02 kg	0,01 kg	0,01 kg
40	M8	13	4	12	17,5	0,02 kg	0,01 kg	0,01 kg
50	M10x1,25	12	5	12	20,5	0,04 kg	–	0,02 kg
63	M12x1,25	13	5	20	29	0,09 kg	–	0,04 kg



QM/8000/38 – Piston Rod Swivel Mounting Style ‘AK’

For cylinders with male piston rod thread
Order nut style ‘N2’ separately (page N 1.4.087.03)

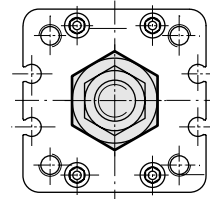
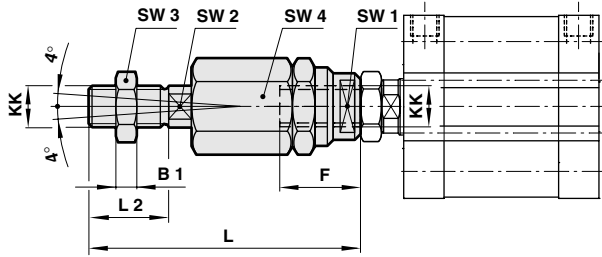

QM/8000/32 – Universal Piston Rod Eye Mounting Style ‘UF’

(Corresponds to DIN ISO 8139)
For cylinders with male piston rod thread
Order nut style ‘N2’ separately (page N 1.4.087.03)

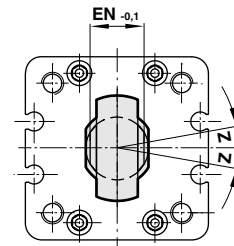
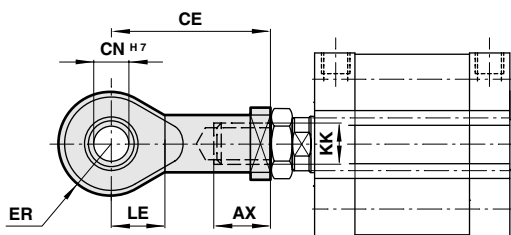

M/P1501/ . . – Nut Style ‘N2’

For cylinders with male piston rod thread

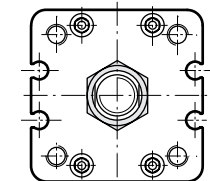
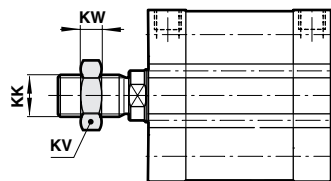

Cylinder Ø	AX	B1	CE	Ø CN H7	EN -0,1	ER	F	KK	KV (A/F)	KW	L
20	20	5	43	10	14	14	26	M 10 x 1,25	17	5	73
25	20	5	43	10	14	14	26	M 10 x 1,25	17	5	73
32	20	5	43	10	14	14	26	M 10 x 1,25	17	5	73
40	22	6	50	12	16	16	26	M 12 x 1,25	19	6	77
50	28	8	64	16	21	21	34	M 16 x 1,5	24	8	106
63	28	8	64	16	21	21	34	M 16 x 1,5	24	8	106

Cylinder Ø	L 2	LE	SW 1 (A/F)	SW 2 (A/F)	SW 3 (A/F)	SW 4 (A/F)	Z	Style ‘AK’	Style ‘N2’	Style ‘UF’
20	20	15	19	12	17	30	13°	0,20 kg	0,01 kg	0,09 kg
25	20	15	19	12	17	30	13°	0,20 kg	0,01 kg	0,09 kg
32	20	15	19	12	17	30	13°	0,20 kg	0,01 kg	0,09 kg
40	24	17	19	12	19	30	13°	0,20 kg	0,01 kg	0,13 kg
50	32	22	30	19	24	42	15°	0,65 kg	0,01 kg	0,33 kg
63	32	22	30	19	24	42	15°	0,65 kg	0,01 kg	0,33 kg

M/P72816 – Groove Key

Weight: 0,010 kg

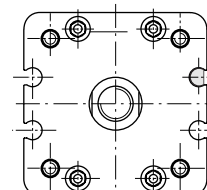
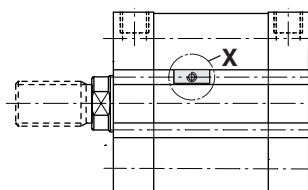

Section X

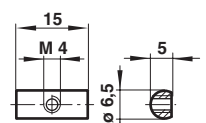



Spares

Sprung in

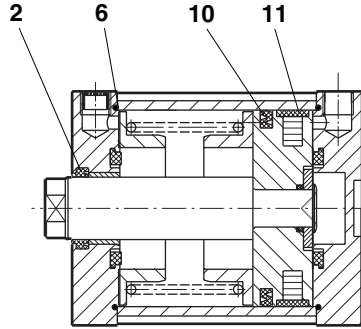

Cylinder Ø	Model	Spares kit	Comprising Item	Description	Quantity
20	RM/191020/M, RM/191020/MX	QM/192020/00	2	Piston rod seal	1
25	RM/191025/M, RM/191025/MX	QM/192025/00	6	'O'-ring	2
32	RM/191032/M, RM/191032/MX	QM/192032/00	10	Piston seal	1
40	RM/191040/M, RM/191040/MX	QM/192040/00	11	Wear ring (Ø 63 mm)	1
50	RM/191050/M, RM/191050/MX	QM/192050/00			
63	RM/191063/M, RM/191063/MX	QM/192063/00			

Note: Please quote the cylinder type number when ordering spares kits

Spares

Sprung out

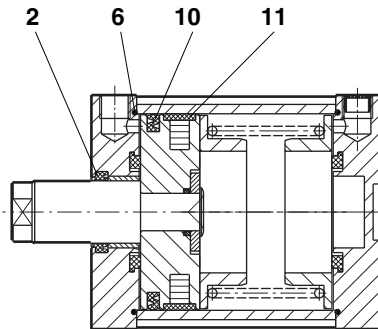

Cylinder Ø	Model	Spares kit	Comprising Item	Description	Quantity
20	RM/193020/M, RM/193020/MX	QM/192020/00	2	Piston rod seal	1
25	RM/193025/M, RM/193025/MX	QM/192025/00	6	'O'-ring	2
32	RM/193032/M, RM/193032/MX	QM/192032/00	10	Piston seal	1
40	RM/193040/M, RM/193040/MX	QM/192040/00	11	Wear ring (Ø 63 mm)	1
50	RM/193050/M, RM/193050/MX	QM/192050/00			
63	RM/193063/M, RM/193063/MX	QM/192063/00			

Note: Please quote the cylinder type number when ordering spares kits

Warning

These products are intended for use in industrial compressed air systems only. Do not use these products where pressures and temperatures can exceed those listed under 'Technical Data'.

Before using these products with fluids other than those specified, for non-industrial applications, life-support systems, or other applications not within published specifications, consult NORGREN.

Through misuse, age, or malfunction, components used in fluid power systems can fail in various modes.

The system designer is warned to consider the failure modes of all component parts used in fluid power systems and to provide adequate safeguards to prevent personal injury or damage to equipment in the event of such failure.

System designers must provide a warning to end users in the system instructional manual if protection against a failure mode cannot be adequately provided.

System designers and end users are cautioned to review specific warnings found in instruction sheets packed and shipped with these products.